

Designed as an alternative and upgrade to sight gauge devices, Magnetic Level Indicators (MLI) from Orion Instruments® are manufactured to reliably and continuously provide accurate liquid level in a wide range of applications. Our MLI product line—manufactured globally at multiple facilities—requires minimum maintenance and eliminates vapor or liquid emission problems, which are common with sight glass. Orion Instruments specializes in precision-engineered excellence and offers highly-customized configurations and options for process environments, including those with extreme temperatures and pressures.

The Atlas™ is the standard high-performance magnetic level indicator from Orion Instruments®. Atlas is a single-chamber design with either a 2", 2½", or 3" chamber diameter, as required by the application. There are several configuration styles including top mount models. Consult factory for options not listed in this bulletin.

The Atlas MLI is produced in a wide range of materials, including exotic alloys and plastics. Orion offers the most complete selection of process connection types and sizes in the industry.

Atlas can be equipped with a variety of level transmitters and switches as well as flag and shuttle indicators with or without stainless steel scales. This enables the MLI to be a complete level and monitoring control.

APPLICATIONS

- Feedwater heaters
- Industrial boilers
- Oil/water separators
- Flash drums
- Surge tanks
- Gas chillers
- Deaerators
- Blowdown flash tanks
- Hot wells
- Vacuum tower bottoms
- Alkylation units
- Boiler drums
- Propane vessels
- Storage tanks



FEATURES

- Numerous chamber styles (or configurations) are available for each design. Consult factory for options not listed in this bulletin.
- Complete range of level switches and level transmitters
- Fabricated, non-magnetic chamber assembly produced in a wide range of metal and plastic materials
- A wide range of process connections is available
- Precision manufactured float with internal magnets and magnetic flux ring
- ASME and EN 1092-1 process connections available
- Flag or shuttle type indicator with stainless steel scale to measure height or percentage of level, volume or content
- Standard float stop springs at top and bottom of chamber
- Exceptional code qualified welding

reveal™

WIDE VIEW INDICATOR

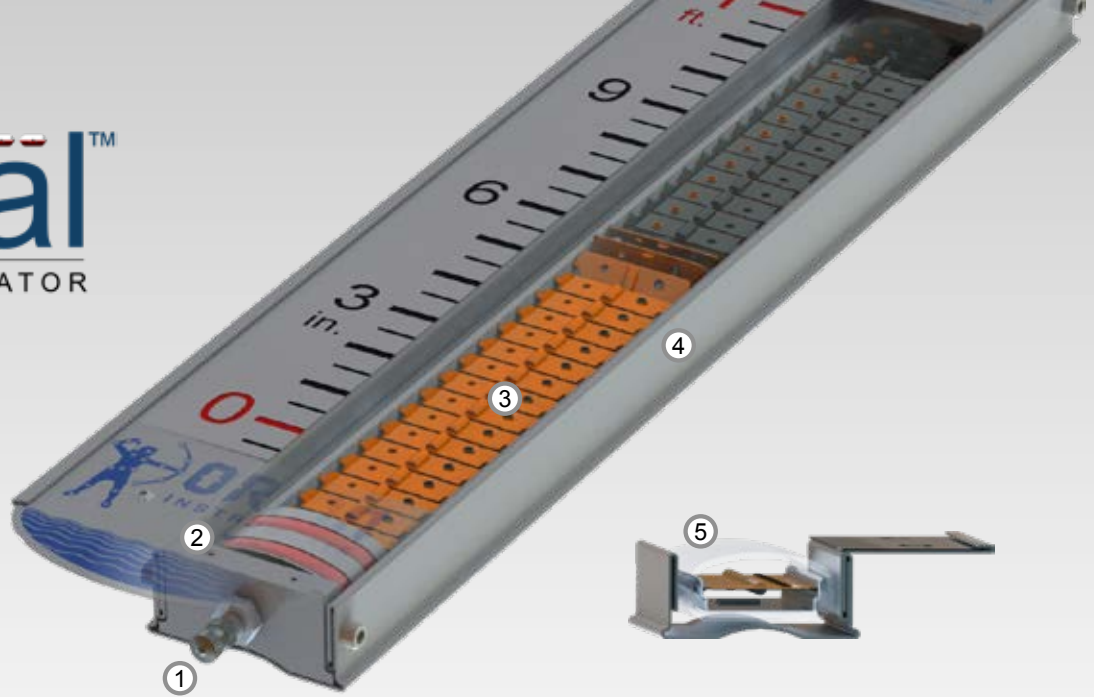

- ① InstaSeal™ valve allows for an effective vacuum seal
- ② Double custom D-ring end plug ensures a reliable seal that keeps moisture out
- ③ All-metal high contrast powder coated or anodized flags are wider to enhance overall visibility
- ④ Robust 316 stainless steel enclosure designed to face the elements
- ⑤ Extruded shatter-resistant viewing window enhances visibility and allows the flags to position closely to the float, enhancing the magnetic coupling

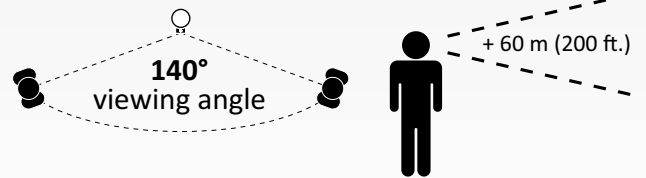

Scale Options:

- Inches / Feet
- Running Inches
- Millimeters / Meters
- Centimeters / Meters
- Percent (5% increments)
- Gallons
- Liters



The patented REVEAL™ indicator incorporates a *positive-stop* design which limits the rotation of each flag to a half-turn. This eliminates “over-flipping” which commonly occurs on other indicator designs.



Each flag contains a high-strength magnet

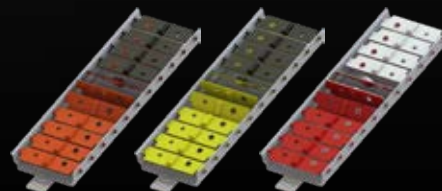

Standard flag and shuttle offering. Custom colors available.



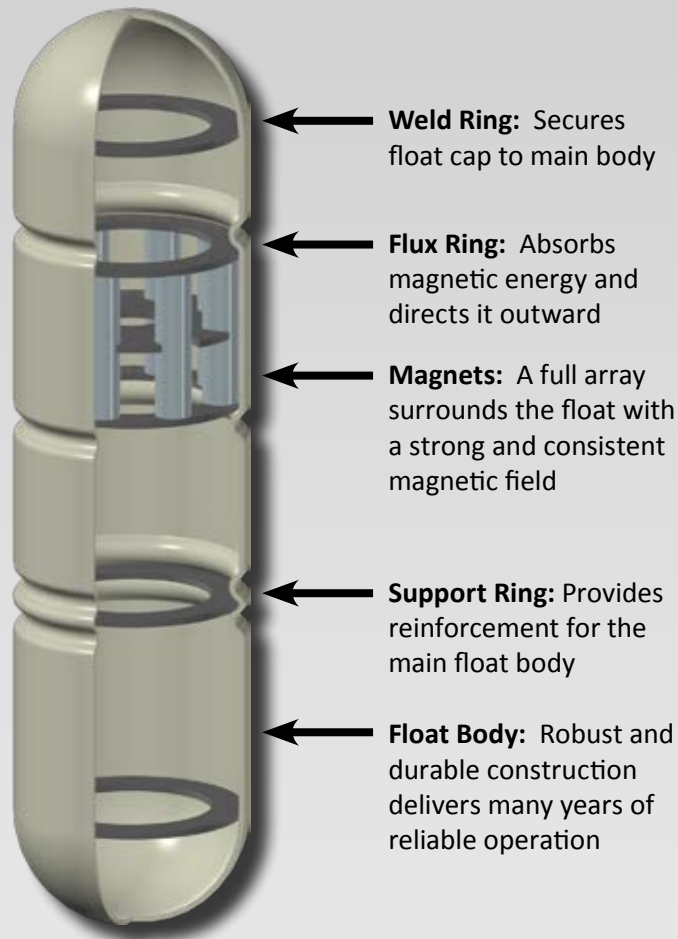

Weld Ring: Secures float cap to main body

Flux Ring: Absorbs magnetic energy and directs it outward

Magnets: A full array surrounds the float with a strong and consistent magnetic field

Support Ring: Provides reinforcement for the main float body

Float Body: Robust and durable construction delivers many years of reliable operation

ORION FLOAT TECHNOLOGY

The float contained within the magnetic level indicator is perhaps the most important element of the instrument. Its structural design, volume displacement, weight, and buoyancy force are all carefully considered when a float is specified for a particular application.

Orion engineers have designed and tested hundreds of floats to gather the most accurate data available. We have designs for thousands of unique applications around the world, including high pressure, high temperature, and interface.

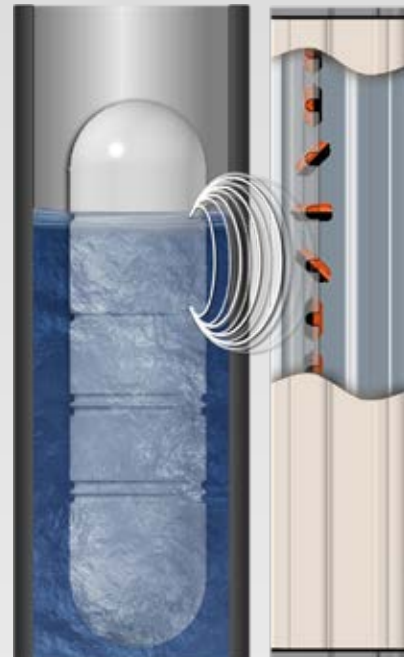

The float's 360° magnet assembly produces a strong and consistent flux array allowing visual indication through chambers as thick as schedule 160.

CAPABILITIES

- Process pressures up to 310 bar (4,500 psig) ①
- Process Temperatures up to 538 °C (1,000 °F) ①
- Total level specific gravities as low as 0.25 ①
- Interface float designs available for liquid specific gravity differentials as little as 0.1
- Adequate buoyancy to operate effectively and freely in many viscous liquids, including crude oil

① Maximum capabilities can vary depending on combination of pressure, temperature, and media specific gravity.

OPTIONS

- Teflon-S® PTFE and PFA slip-assistant coating
- Special coatings for abrasion and chemical resistance
- Float retrieval hook
- Float Projection Curve: If the liquid density changes, a float curve will reveal the offset

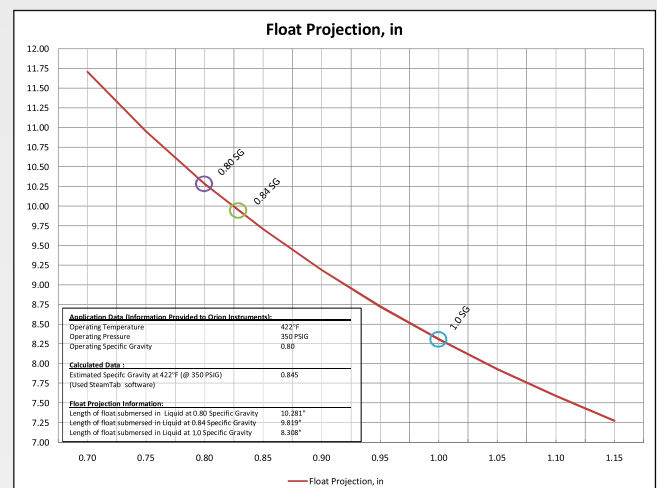

Float Projection Curve

MAGNETIC LEVEL INDICATOR SPECIFICATIONS

Design	Single chamber
Materials of construction – Chamber	Metal alloys: see selection table digit 5
– Rail & window	316 stainless steel (Reveal™) rail with polycarbonate window Aluminum rail with polycarbonate or glass window
– Float	316 stainless steel and titanium (exotic alloys available); varies depending on process conditions
Construction options	ASME B31.1, ASME B31.3, ASME code Stamp [U,Um,S], PED and NACE
Approvals	Industrial, Industrial PED: ATEX II 1 G c T6 (non-electrical equipment)
Certified material test report (CMTR)	Available upon request
Pressure class ratings	ASME 150#, 300#, 600#, 900#, 1500#, 2500# EN PN16, PN25, PN40, PN63, PN100, PN160, PN250, PN320
Process connection sizes	½" to 6" / DN 15 to DN 150
Process connection types	Refer to page 10 for detail
Measuring range	30 to 1524 cm (12 to 600 inches)
Temperature range	-196 to +538 °C (-320 to +1000 °F)
Pressure range	Full vacuum to 310 bar (4500 psi)
Specific gravity range	Min. 0.25
Visual Indicators	Magnetically actuated flag assembly in contrasting orange/black, yellow/black, red/white colors, or high visibility shuttle follower (custom colors available)
REVEAL™ flag assembly seal	Vacuum and sealed with double D-ring & InstaSeal™ valve
REVEAL™ visual indicator	Visible from 60 m (200')
Ratings of REVEAL visual indicator	IP 68
Aluminum visual indicator	Visible from 30 m (100')
Scale options	Etched stainless steel with either height or percentage units (custom markings available)
Switch options	Electric microswitch Electric reed switch
Transmitter options	Model JM4 Jupiter magnetostrictive (refer to Orion bulletin ORI-150) Analog reed chain transmitter
High temperature options	Electric or steam tracing with or without special high temperature insulation
High temperature insulation	Fiberglass material
Low temperature options	Cryogenic insulation with special polymeric frost extension

Atlas™ MLI

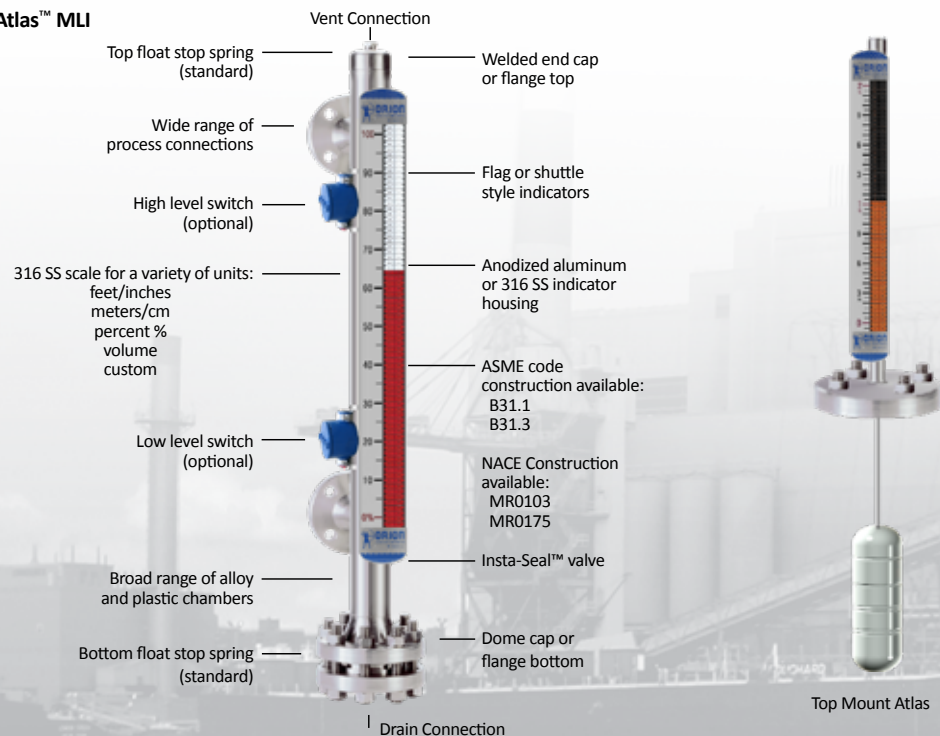

HIGH-TEMPERATURE INSULATION

Orion specializes in custom fiberglass insulation blankets for MLIs of all shapes and sizes. They are constructed with high-quality materials capable of constant contact with temperatures up to 538 °C (1000 °F). This insulation is available as personnel protection or with heat tracing options for freeze protection or process temperature maintenance.

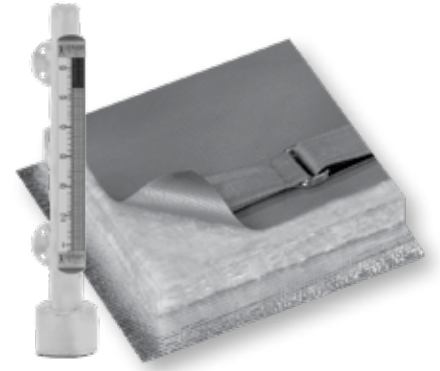

CRYOGENIC INSULATION & FROST EXTENSION

To facilitate operation where the product is kept cold via chillers, refrigerants, and condensers, cryogenic insulation is provided. By insulating the MLI with a specialized cryogenic jacket, process temperatures can be maintained in the liquid state down to -196 °C (-320 °F).

A frost extension option is available to prevent ice from collecting on the visual indicator, thereby decreasing the visibility. The extension is constructed of durable acrylic plastic and is provided standard with all cryogenic insulation.

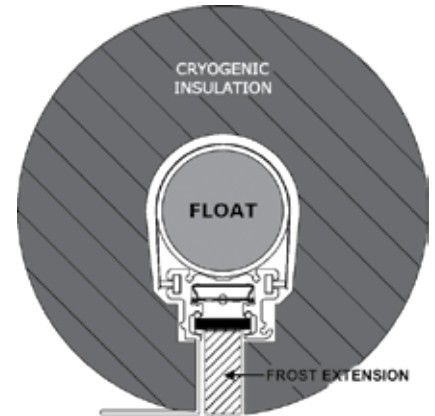

MAGNETIC PARTICLE TRAP

Magnetic Particle Traps, or magtraps, provide protection for Orion's line of Magnetic Level Indicators. Particles composed mostly of ferrite, often from carbon steel piping, are widespread throughout process piping. These particles enter the MLI via the process connections during normal fill and drain operations. The magnetic float located inside the MLI attracts these particles over time. Eventually, the buildup will be enough to cause the float to become stuck inside the chamber. This results in the MLI either reading inaccurately or not at all. The trap collects the particles which can be cleaned periodically to ensure continued operation of the magnetic level indicator.

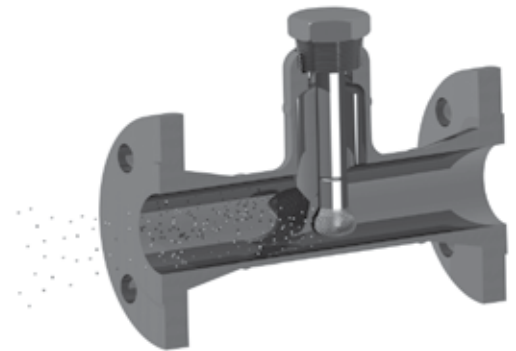

HEAT TRACING: ELECTRIC & STEAM

For applications where process freeze protection or temperature maintenance is required, heat tracing will allow the MLI to operate uninterrupted throughout harsh, cold conditions.

Electric Heat Tracing is available in self-regulating, constant wattage, and mineral insulated varieties. Contact the factory for more information.

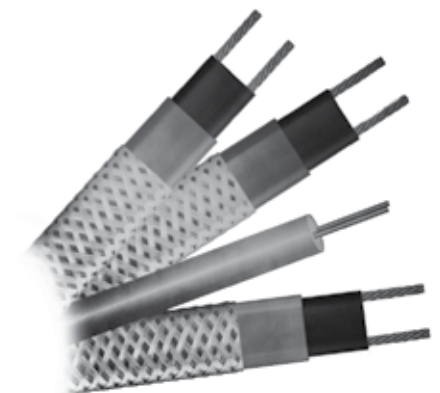

JUPITER MODEL JM4 MAGNETOSTRICTIVE TRANSMITTER SPECIFICATIONS

Measuring Range:	15 to 999 cm (6 to 400 inches)
Resolution:	.4 mm (.014")
Repeatability:	±0.005% of full span or 0.356 mm (0.014 inches) (whichever is greater)
Linearity:	0.8 mm (0.030 inches) or 0.01% of probe length (whichever is greater)
Upper Dead Zone:	less than 7.6 cm (3 inches) when bottom mounted electronics
Lower Dead Zone:	less than 7.6 cm (3 inches) when top mounted electronics
Damping:	0 – 10 seconds; adjustable
Power (at terminals) 2-wire:	HART®: 16 to 36 VDC FOUNDATION fieldbus™ Explosion Proof: 9 to 17.5 VDC FISCO/FNICO: 9 to 32 VDC
Signal Output:	4-20 mA with HART®: 3.8 to 20.5 mA usable FOUNDATION fieldbus™: H1 (ITK Ver. 6.1.1)
Display:	Graphic liquid crystal display
Housing Material:	IP67/die-cast aluminum A413 (<0.4% copper); optional stainless steel
Area Classifications:	USA/Canada/ATEX/IECEx/INMETRO/Korea XP, IS, NI, DIP (see specific product literature for more detail)
Safety Integrity Level:	SIL rating pending
Process Temperature:	External Mount: -195 to +454 °C (-320 to +850 °F) No insulation -40 to +79 °C (-40 to +175 °F) Requiring insulation up to +454 °C (+850 °F)
Ambient Temperature at Electronics:	-40 to +80 °C (-40 to +175 °F) LCD: -20 to +70 °C (-5 to +160 °F)

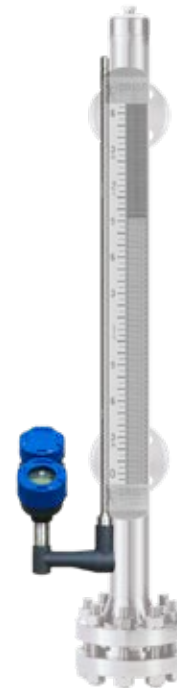

Jupiter®
Model JM4
on Atlas™

OCT REED CHAIN TRANSMITTER SPECIFICATIONS

Measuring Range:	15 to 503 cm (6 to 198 inches)
Resolution:	13 mm (±0.50 inches)
Repeatability:	<6 mm (0.25 inches)
Non-Linearity:	<0.4% full span averaged over span
Upper Transition Zone:	10.2 cm (4 inches)
Lower Transition Zone:	10.2 cm (4 inches)
Power Input:	12 to 36 VDC (2-wire)
Signal Output:	4 to 20 mA
Housing Type:	NEMA 4X, IP66
Housing Material:	Cast Aluminum or 316 SS
Area Classifications:	FM/CSA EP
Process Temperature:	No insulation: -40 to +93 °C (-40 to +200 °F) Requiring insulation: up to +260 °C (+500 °F)
Ambient Temperature at Electronics:	-40 to +70 °C (-40 to +158 °F)
Mounting Arrangement:	External mount probe with integral top or bottom mounted electronics



OCT
on Atlas™

ELECTRONIC SWITCH SPECIFICATIONS

Model:	OES	ORS
Description:	DPDT magnetically actuated, bi-stable cam drive snap action switch	Hermetically sealed bi-stable reed switch
Supply Voltage:	10.1 amp; 125-250 VAC	250VAC/150VDC max
Maximum Dead Band:	±0.75" float travel	±0.50" float travel
Temperature Range:	No insulation -50 to +121 °C (-58 to +250 °F) Requiring insulation up to +260 °C (+500 °F)	No insulation -50 to +121 °C (-58 to +250 °F) Requiring insulation up to +260 °C (+500 °F)
Enclosure Material:	Cast aluminum (standard)	Stainless steel

Consult factory for pneumatic switch specifications.

Consult the individual MLI accessory catalogs for their respective hazardous location approvals.



Model OES



Model ORS

MOUNTING TO ATLAS – MODEL OES

Position the OES switch on the MLI body so that the centerline of the switch housing is at the desired switch point level. Remove the housing cover and ensure that the switch is oriented so that the arrow on the internal mechanism is pointing toward the top of the MLI. Install the clamps around the MLI and over the mounting brackets on the top and bottom of the housing. Tighten the clamps until the switch is firmly secured to the MLI. Replace the housing cover. If required, place the insulation between the MLI body and the OES switch before securing the clamps.

WIRING – MODEL OES

The lower cable entry is protected with a plastic plug. The upper opening is sealed with a steel plug. If it is preferable to wire through the upper cable entry, the steel plug may be moved to the lower opening. The DPDT switch has two sets of contacts. Refer to the wiring diagram or label on the mechanism itself.

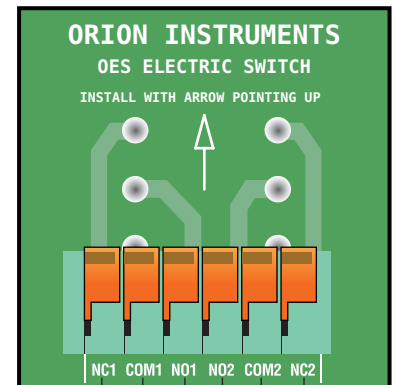

FLOAT BELOW SWITCH

MOUNTING TO ATLAS – MODEL ORS

Position the ORS switch on the MLI body so that the centerline of the stainless steel tube which houses the switch is at the desired switch point level. The switch should be oriented so that the green grounding screw is closest to the top of the MLI. Install the clamps around the MLI and over the mounting tabs of the switch. Tighten the clamps until the switch is firmly secured to the MLI. If required, place the insulation between the MLI body and the ORS switch before securing the clamps.

WIRING – MODEL ORS

The switch leads are color coded as follows:

- white = common
- black = normally closed (float below switch)
- red = normally open

The wiring diagram shows both conditions of the switch relative to the float.

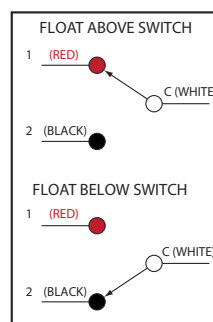

MODEL NUMBER - ATLAS

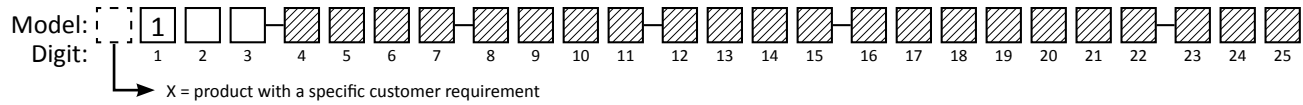

1 | PRODUCT NAME

1	Atlas™ Magnetic Level Indicator
---	---------------------------------

2 | UNIT OF MEASUREMENT

E	English (inches)
M	Metric (cm)

3 | MOUNTING CONFIGURATION & CHAMBER CONSTRUCTION

Connection orientation	Chamber top	Chamber bottom
1 Side / Side	Welded end cap	Flange
2 Side / Side	Flange	Welded end cap
3 Side / Side	Flange	Flange
5 Top / Bottom*	Flange	Flange
7 Top / Side	Welded end cap with process connection	Flange
9 Side / Bottom	Flange	Welded end cap with process connection

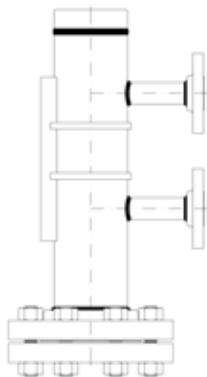

Option 1

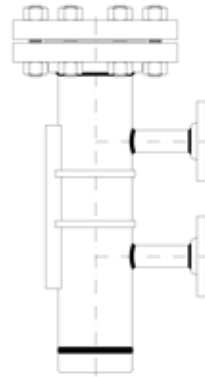

Option 2



Option 3

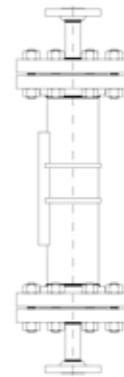

Option 5

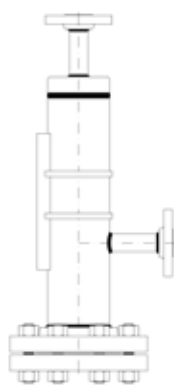

Option 7

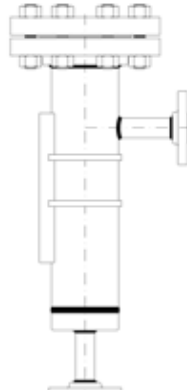

Option 9

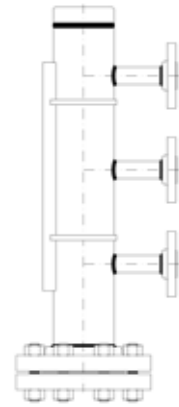

Option 1 with three process connections

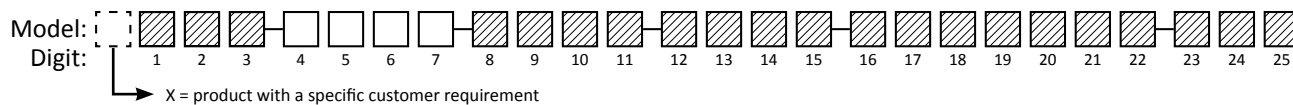

4 | CHAMBER/FLANGE RATING

ASME	
A	150#
B	300#
C	600#
D	900#
E	1500#
F	2500#

EN 1092-1	
1	PN 16
2	PN 25
3	PN 40
4	PN 63
5	PN 100
6	PN 160
7	PN 250
8	PN 320

5 | MATERIAL OF CONSTRUCTION

Metallic	
A	316/316L stainless steel chamber
B	316/316L stainless steel chamber with carbon steel fittings & flanges
C	304/304L stainless steel chamber
D	304/304L stainless steel chamber with carbon steel fittings & flanges
G	321 stainless steel
H	347 stainless steel
J	904L stainless steel
N	Titanium
P	Monel®
Q	Hastelloy C-276
R	Alloy 20
S	Inconel® 625
T	Incoloy® 825
U	254 SMO

6 | CONSTRUCTION GRADE

Metallic construction – Non-PED	
1	Industrial Grade (standard)
2	ASME B31.1 for Power Piping Standard
3	ASME B31.3 for Process Piping Standard ①
4	Industrial Grade with NACE MR0175/0103
6	ASME B31.3 and NACE MR0103/0175 ①
8	Industrial Grade (extruded outlet)
9	ASME B31.3 (extruded outlet) ①

Metallic construction – PED	
D	NACE MR0175/MR0103
E	ASME B31.3 & NACE MR0175/MR0103 ①
J	Industrial
Z	ASME B31.3 ①

① Consult factory if ASME B31.3 certification is required on carbon steel constructions with design temperatures below -17 °C (0 °F).

7 | CHAMBER FLANGE(S) TYPE

ASME flanges	
A	RF slip-on (standard for digit 4 = A, B, C)
B	RF weld neck
C	RF Socketweld Flange (digit 4 = A or B)
J	RTJ weld neck (standard for digit 4 = D, E, F)

EN 1092-1 flanges	
6	Weld neck (Type 11) EN 1092-1 Type A
7	Weld neck (Type 11) EN 1092-1 Type B2 (standard for digit 4 = 4, 5, 6, 7, 8)
8	Weld neck (Type 11) EN 1092-1 Type B1 (standard for digit 4 = 1, 2, 3)
N	No chamber flange

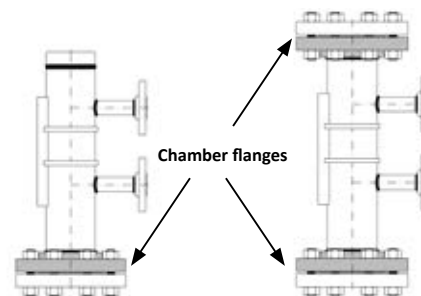

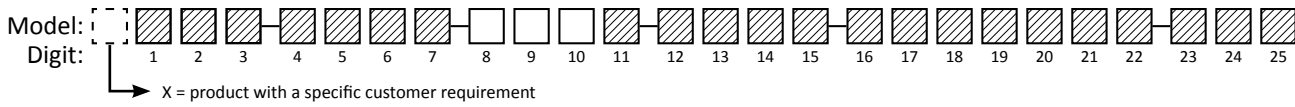

8 | PROCESS CONNECTION TYPE

Threaded or Welded	
M	Threaded NPT-M (male)
P	Pipe nipple plain end
R	Pipe nipple butt weld end
N	Threaded NPT-F (female) ①
Q	Socket weld ①
W	Threadolet™ ②
T	Sockolet™ ②
S	Weldolet™ ②

ASME ④	
A	RF slip-on flange ③
B	RF weld neck flange
C	RF socketweld flange
J	RJ weld neck flange

EN 1092-1 ④	
6	Weld neck (Type 11) EN 1092-1 Type A
7	Weld neck (Type 11) EN 1092-1 Type B2
8	Weld neck (Type 11) EN 1092-1 Type B1

- ① Only available in combination with digit 9 = A, B or C.
- ② Consult factory for sizes > 1".
- ③ Machined flange (to smaller pipe size) if process connection size ≥ chamber size (e.g., 2"/DN50 process connection and 2" chamber).
- ④ Pressure ratings for flanges are by default the same as selected in Digit 4

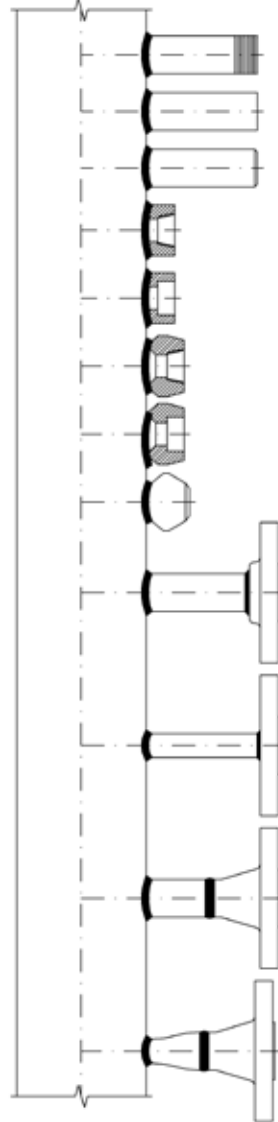

- Threaded NPT-M, option M
- Pipe nipple plain end, option P
- Pipe nipple butt weld end, option R
- Threaded NPT-F, option N
- Socket weld, option Q
- Threadolet NPT-F, option W
- Sockolet, option T
- Weldolet, option S
- Slip-on flange, option A
(process connection size < chamber size)
- Machined flange, option A
(process connection size ≥ chamber size)
- Weld neck flange, option B, J, 8, 7, 6
(process connection size < chamber size)
- Weld neck flange, option B, J, 8, 7, 6
(process connection size ≥ chamber size)

9 | PROCESS CONNECTION SIZE

ASME		EN 1092-1	
A	1/2"	1	DN 15
B	3/4"	2	DN 20
C	1"	3	DN 25
D	1 1/2"	4	DN 40
E	2"	5	DN 50
F	2 1/2"	6	DN 65
G	3"	7	DN 80
H	4"	8	DN 100
J	6"	9	DN 150

10 | GASKET STYLE FOR CHAMBER FLANGE(S)

Gaskets for metallic flanges	
A	Flexible graphite fiber ①
B	Spiral wound with graphite filler and carbon steel outer ring ②
C	Spiral wound with graphite filler, inner ring included matching chamber material, and carbon steel or stainless steel outer ring based on chamber material ②
D	RTJ oval ring ④
E	RTJ octagonal ring ③ ④
N	None (if mating flanges are not supplied)

- ① Standard gasket for RF flanges with rating up to 300# / PN 63.
- ② Standard gasket options for RF flanges with rating > 300# / PN 63. Winding material matches chamber material.
- ③ Standard ring joint for RJ ANSI flanges (digit 7 = J).
- ④ Ring joint material matches flange material.

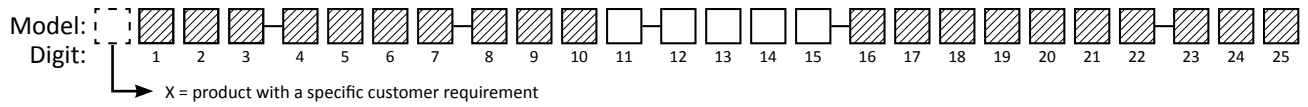

11 | CHAMBER BOLTING MATERIAL

A	304 Stainless steel class 2	A193 Gr. B8 Class 2 / A194 Gr. 8
C	316 stainless steel class 2	A-193 Gr B8M class 2 / A-194 Gr 8M
D	316 stainless steel class 2 with PTFE coating	A-193 Gr B8M class 2 / A-194 Gr 8M
G	316 stainless steel class 2 + NACE	A-193 Gr B8M class 2 / A-194 Gr 8MA

S	Alloy steel with zinc plating (+210 °C (+390 °F) is maximum temp for zinc-plated bolting)	A-193 Gr B7 / A-194 Gr 2H
T	Alloy steel with zinc plating + NACE (+210 °C (+390 °F) is maximum temp for zinc-plated bolting)	A-193 Gr B7M / A-194 Gr 2HM
M	Alloy steel ①	A-193 Gr B7 / A-194 Gr 2H
P	Alloy steel + NACE ①	A-193 Gr B7M / A-194 Gr 2HM

N	None (if mating flanges are not supplied)	
---	---	--

① Available only in combination with digit 5 = B or D.

12 | VENT SIZE

N	None
---	------

ASME	
1	1/2"
2	3/4"
3	1"
4	1 1/2"
5	2"

EN 1092-1	
A	DN 15
B	DN 20
C	DN 25
D	DN 40
E	DN 50

13 | VENT TYPE

N	None
---	------

ASME	
1	Threaded NPT-F (female) with plug
2	Socket weld
3	Threaded NPT-M (male)
4	Pipe nipple plain end
5	Pipe nipple butt weld end
6	RF slip-on flange ①
7	RF weld neck flange ①
9	RJ weld neck flange ①

Valves	
A	Ball Valve, FNPT × FNPT
B	Ball Valve, SW × SW
C	Ball Valve, SW × FNPT
D	Gate Valve, FNPT × FNPT
E	Gate Valve, SW × SW
F	Gate Valve, SW × FNPT
G	RF Flange Ball Valve w/spool
H	RF Flange Gate Valve w/spool

EN 1092-1	
R	Weld neck (Type 11) EN 1092-1 Type A ①
S	Weld neck (Type 11) EN 1092-1 Type B2 ①
T	Weld neck (Type 11) EN 1092-1 Type B1 ①

① Pressure class of vent flange is as selected in digit 4.

14 | DRAIN SIZE

N	None
---	------

ANSI	
1	1/2"
2	3/4"
3	1"
4	1 1/2"
5	2"

EN (DIN)	
A	DN 15
B	DN 20
C	DN 25
D	DN 40
E	DN 50

15 | DRAIN TYPE

N	None
---	------

ASME	
1	Threaded NPT-F (female) with plug
2	Socket weld
3	Threaded NPT-M (male)
4	Pipe nipple plain end
5	Pipe nipple butt weld end
6	RF slip-on flange ①
7	RF weld neck flange ①
9	RJ weld neck flange ①

Valves	
A	Ball Valve, FNPT × FNPT
B	Ball Valve, SW × SW
C	Ball Valve, SW × FNPT
D	Gate Valve, FNPT × FNPT
E	Gate Valve, SW × SW
F	Gate Valve, SW × FNPT
G	RF Flange Ball Valve w/spool
H	RF Flange Gate Valve w/spool

EN 1092-1	
R	Weld neck (Type 11) EN 1092-1 Type A ①
S	Weld neck (Type 11) EN 1092-1 Type B2 ①
T	Weld neck (Type 11) EN 1092-1 Type B1 ①

① Pressure class of drain flange is as selected in digit 4.

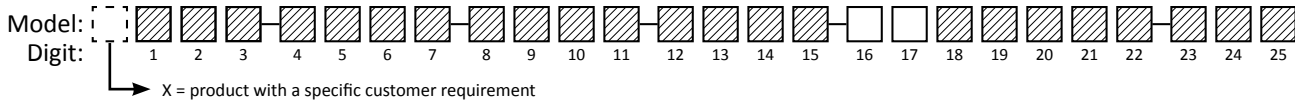

16 | CHAMBER MODIFICATION FOR MOUNTING OF OPTIONAL SWITCHES AND/OR TRANSMITTER

ATLAS can be combined with various externally mounted accessories, including switches and transmitters. In these cases minor changes to the chamber and float design may be required.

For digit 16, match up the MLI product with the appropriate transmitter, switch or combination of both.

For OES/ORS switch, refer to the switch selection data for temperature limitations and insulation options. Match up the switch model code digit 7 with the MLI model codes 16 and 17.

For OCT transmitter, refer to OCT information for temperature limitations and match up the OCT model code with the MLI model codes 16 and 17.

For Jupiter transmitter, refer to JM4 information for temperature limitations and possible mounting configurations.

Match up the Jupiter model code with the MLI model codes 16 and 17.

All transmitters and switches must be ordered separately.

N	No switch or transmitter added
---	--------------------------------

Switch only (no transmitter)	
Y	OES or ORS switch(es) clamp mounted to chamber
Z	OES or ORS switch(es) attached to switch mount rod

OCT reed chain transmitter (no switches)	
8	Top mount
9	Bottom mount

Jupiter magnetostrictive transmitter only (no switches)	
1	Top mount without offset ①
2	Top mount offset, with or without high temperature design
3	Bottom mount offset, with or without high temperature design

Jupiter magnetostrictive transmitter with at least one OES or ORS switch		
Mounting of Jupiter	Mounting of switches	
	clamp mounted to chamber	attached to switch mount rod
Top mount without offset ①	A ②	L ③ ④
Top mount offset, with or without high temperature bend	B	M ④
Bottom mount offset, with or without high temperature bend	C	P ④

① Available only in combination with digit 3 = 1 and digit 13 = N or 1

② Jupiter: max. 79 to 454 °C (175 to 850 °F) with insulation

③ Jupiter: max. 79 to 454 °C (175 to 850 °F) with insulation (digit 17 = A, C)

④ Available when digit 17 = A, B, C or D

17 | INSULATION OPTIONS

N	None ①	Indicator: max. 121 °C (250 °F) OCT transmitter: max. 93 °C (200 °F) Jupiter transmitter: max. 79 °C (175 °F)
---	--------	---

Insulation pad for indicator and transmitter			
E	Indicator only	digit 16 = N, Y	121 °C (250 °F) < T ≤ 260 °C (500 °F)
F	Indicator only	digit 16 = N	261 °C (501 °F) < T ≤ 537 °C (1000 °F)
U	Transmitter only	digit 16 = 1, 2, 3, A, B, C ② digit 16 = 8, 9	79 °C (175 °F) < T ≤ 260 °C (500 °F) 93 °C (200 °F) < T ≤ 260 °C (500 °F)
R	Indicator & transmitter	digit 16 = 1, 2, 3, A, B, C ② digit 16 = 8, 9	121 °C (250 °F) < T ≤ 260 °C (500 °F) 121 °C (250 °F) < T ≤ 260 °C (500 °F)
K	Transmitter only	digit 16 = 1, 2, 3, A, B, C ③ & digit 18 = N	261 °C (501 °F) < T ≤ 454 °C (850 °F)
V	Indicator & transmitter	digit 16 = 1, 2, 3, A, B, C ②	261 °C (501 °F) < T ≤ 454 °C (850 °F)

Insulation blanket for personnel protection		
A	Chamber pipe only	up to 260 °C (500 °F)
B	Chamber pipe only	261 to 538 °C (501 to 1000 °F)
C	Chamber and flanges	up to 260 °C (500 °F)
D	Chamber and flanges	261 to 538 °C (501 to 1000 °F)

Cryogenic insulation	
L	Process temperature down to -100 °C (-150 °F)
P	Process temperature down to -196 °C (-320 °F)

Other options for temperature maintenance or freeze protection	
H	Electric heat tracing ④
S	Steam tracing (3/8" tubing) ④
J	Steam jacket (1/2" NPT inlet/outlet) ④

① It is recommended to not fully enclose the MLI indicator in boiler / steam drum applications

② Matches external mount Jupiter with digit 3 = E, F, H

③ Matches external mount Jupiter with digit 3 = K, L, M

④ With maximum temperature up to +260 °C (+500 °F); consult factory for application temperature higher than +260 °C (+500 °F).

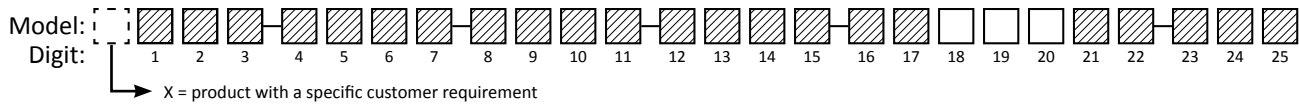

18 | MEASUREMENT TYPE & INDICATION STYLE

Total level		
1	Orange / black metal flags	
2	Yellow / black metal flags	
3	Red / white metal flags (standard)	
4	Red / silver metal flags	+371 °C (+700 °F) and above
A	Orange / black metal flags with yellow float diagnostics ①	
B	Yellow / black metal flags with orange float diagnostics ①	
C	Red / white metal flags with yellow float diagnostics ①	
D	Red / silver metal flags with black float diagnostics ①	+371 °C (+700 °F) and above
S	Fluorescent orange shuttle / follower ②	Maximum Temperature +120 °C (+249 °F)
Interface level		
5	Orange / black metal flags	
6	Yellow / black metal flags	
7	Red / white metal flags (standard)	
8	Red / silver metal flags	+371 °C (+700 °F) and above
F	Orange / black metal flags with yellow float diagnostics ①	
G	Yellow / black metal flags with orange float diagnostics ①	
H	Red / white metal flags with yellow float diagnostics ①	
J	Red / silver metal flags with black float diagnostics ①	+371 °C (+700 °F) and above
T	Fluorescent orange shuttle / follower ②	Maximum Temperature +120 °C (+249 °F)
N	No indicator (For external use of external Jupiter mount only)	

① Float diagnostics is a safety feature which indicates a contrasting color on the visual indicator when the float has fallen below the lowest measurable point on the scale. This can occur when the specific gravity of the liquid drastically decreases or the float collapses due to a pressure spike.

② Only available with stainless steel indicator, refer to digit 19.

19 | INDICATOR HOUSING MATERIAL & MEASURING SCALE ①

reveal Wide View Stainless Steel indicator	
A	Foot / Inch Measurement
M	Meter / Centimeter Measurement
C	Running Inch Measurement
D	Percent (0 - 100%) Measurement
E	Gallon Measurement
G	Meter / Millimeter Measurement
H	Foot / Inch with Percent (Dual Scale)
J	Meter / Millimeter with Percent (Dual Scale)
F	Liter Measurement
P	No scale

Anodized Aluminum Housing	
1	Foot / Inch Measurement
3	Running Inch Measurement
4	Percent (0 - 100%) Measurement
5	Gallon Measurement
6	Liter Measurement
7	Meter / Millimeter Measurement
8	Meter / Centimeter Measurement
N	No scale

① Aluminum indicator with glass window is required if the process operating temperature exceeds 800 F (427 C)

20 | CHAMBER CODE

Codes listed are valid for metallic construction (refer to digit 5).

1	2" S10	digit 21 = 2, B, D
2	2" S40	

3	2½" S10
4	2½" S40
5	2½" S80

A	3" S10
B	3" S40
C	3" S80

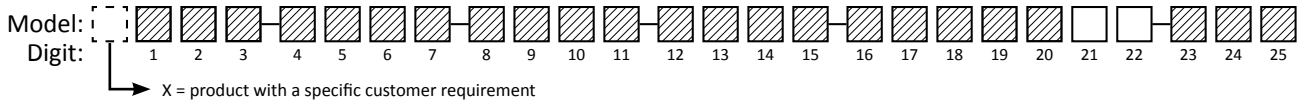

21-22 | FLOAT CODE

Codes listed are valid for metallic construction (refer to digit 5).

Total level measurement

Consult factory for operating S.G. and/or pressure/temperature rating not covered by the table and graphs.

Float types 2 and B (digit 21) cover full 150 # and PN 16 rating of carbon steel and 316/316L SST flanges up to 315 °C (600 °F).

Float type D (digit 21) covers full 300 # rating of 316/316L SST flanges up to 315 °C (600 °F) and of carbon steel flanges up to 200 °C (400 °F).

Float type D (digit 21) covers full PN 25 and PN 40 rating of carbon steel and 316/316L SST flanges up to 315 °C (600 °F).

Pressure rating of floats (see graphs for full pressure drop details):

type 2: max. 23.0 bar @ 40 °C (333 psi @ 100 °F), max. 18.6 bar @ 315 °C (270 psi @ 600 °F);

hydrotest pressure: 27.6 bar @ 40 °C (400 psi @ 100 °F).

type B: max. 34.5 bar @ 40 °C (500 psi @ 100 °F), max. 15.1 bar @ 315 °C (219 psi @ 600 °F);

hydrotest pressure: 41.4 bar @ 40 °C (600 psi @ 100 °F).

type D: max. 74.7 bar @ 40 °C (1083 psi @ 100 °F), max. 32.6 bar @ 315 °C (473 psi @ 600 °F);

hydrotest pressure: 89.6 bar @ 40 °C (1300 psi @ 100 °F).

Chamber rating	150 #, PN 16, PN 25 ①		300 #, 600 #, PN 25, PN 40, PN 63, PN 100
Float mat.	316 SST	Ti ②	Ti ②
Oper. S.G.	Code ③	Code ③	Code ③
0,55 - 0,64	—	BE	-
0,65 - 0,74	—	BE	DE
0,75 - 0,84	2C	BB	DC
0,84 - 0,94	2B	BB	DB
0,95 - 1,04	2B	BB	DB

① Float types 2 and B (digit 21) do not cover full PN 25 rating of flanges in some cases; check the application data (pressure/temperature) with the float graphs before selecting one of these floats.

② Titanium float is factory default

③ Code 99 is used for special float. Depending on the application a factory assigned code different from the listed ones is possible.

Interface level measurement

99	Special float
----	---------------

MODEL NUMBER - TOP MOUNT ATLAS

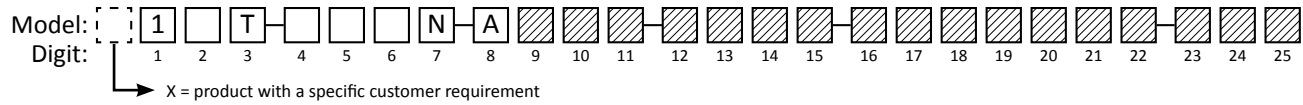

1 | PRODUCT NAME

1	Top Mount Atlas™ Magnetic Level Indicator
---	---

2 | UNIT OF MEASUREMENT

E	English (inches)
M	Metric (cm)

3 | MOUNTING CONFIGURATION & CHAMBER CONSTRUCTION

Connection orientation	Chamber top	Chamber bottom
T	Top Mount	Threaded cap Flanged process connection

4 | CHAMBER/FLANGE RATING

A	150# ASME
B	300# ASME
C	600# ASME
D	900# ASME
E	1500# ASME
F	2500# ASME



Top Mount

5 | MATERIAL OF CONSTRUCTION

A	316/316L stainless steel chamber
B	316/316L stainless steel chamber with carbon steel fittings & flanges
Q	Hastelloy C-276

6 | CONSTRUCTION GRADE

Metallic construction – Non-PED	
1	Industrial Grade (standard)
2	ASME B31.1 for Power Piping Standard
3	ASME B31.3 for Process Piping Standard ①
4	Industrial Grade with NACE MR0175/0103
6	ASME B31.3 and NACE MR0103/0175 ①
Metallic construction – PED	
D	NACE MR0175/MR0103
E	ASME B31.3 & NACE MR0175/MR0103 ①
J	Industrial
Z	ASME B31.3 ①

① Consult factory if ASME B31.3 certification is required on carbon steel constructions with design temperatures below -17 °C (0 °F).

7 | CHAMBER FLANGE(S) TYPE

N	No chamber flange
---	-------------------

8 | PROCESS CONNECTION TYPE

A	ASME RF slip-on flange (machined)
---	-----------------------------------

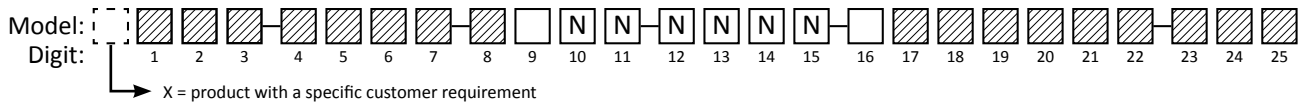

9 | CUSTOMER NOZZLE SIZE

1	2" S10
2	2" S40
A	3" S10
B	3" S40
C	3" S80
D	3" S160
E	4" S10
F	4" S40
G	4" S80
H	4" S160

10 | GASKET STYLE

N	None
---	------

13 | VENT TYPE

N	None
---	------

11 | CHAMBER BOLTING MATERIAL

N	None
---	------

14 | DRAIN SIZE

N	None
---	------

12 | VENT SIZE

N	None
---	------

15 | DRAIN TYPE

N	None
---	------

16 | CHAMBER MODIFICATION FOR MOUNTING OF OPTIONAL SWITCHES AND/OR TRANSMITTER

ATLAS can be combined with various externally mounted accessories, including switches and transmitters. In these cases minor changes to the chamber and float design may be required.

For digit 16, match up the MLI product with the appropriate transmitter, switch or combination of both.

For OES/ORS switch, refer to the switch selection data for temperature limitations and insulation options. Match up the switch model code digit 7 with the MLI model codes 16 and 17.

For OCT transmitter, refer to OCT information for temperature limitations and match up the OCT model code with the MLI model codes 16 and 17.

For Jupiter transmitter, refer to JM4 information for temperature limitations and possible mounting configurations. Match up the Jupiter model code with the MLI model codes 16 and 17.

All transmitters and switches must be ordered separately.

N	No switch or transmitter added
---	--------------------------------

Switch only (no transmitter)	
Y	OES or ORS switch(es) clamp mounted to chamber
Z	OES or ORS switch(es) attached to switch mount rod

OCT reed chain transmitter (no switches)	
8	Top mount
9	Bottom mount

Jupiter magnetostrictive transmitter only (no switches)	
1	Top mount without offset
2	Top mount offset, with or without high temperature design
3	Bottom mount offset, with or without high temperature design

Jupiter magnetostrictive transmitter with at least one OES or ORS switch		
Mounting of Jupiter	Mounting of switches	
	clamp mounted to chamber	attached to switch mount rod
Top mount without offset	A ①	L ② ③
Top mount offset, with or without high temperature bend	B	M ③
Bottom mount offset, with or without high temperature bend	C	P ③

① Jupiter: max. 79 to 454 °C (175 to 850 °F) with insulation

② Jupiter: max. 79 to 454 °C (175 to 850 °F) with insulation (digit 17 = A, C)

③ Available when digit 17 = A, B, C or D

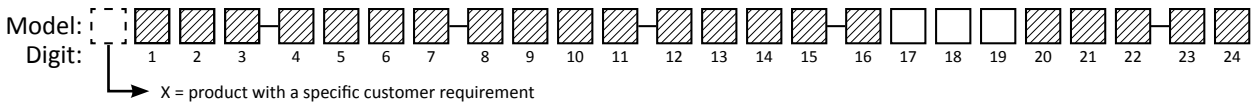

17 | INSULATION OPTIONS

N	None	Indicator: max. 121 °C (250 °F) OCT transmitter: max. 93 °C (200 °F) Jupiter transmitter: max. 79 °C (175 °F)
---	------	---

Insulation pad for indicator and transmitter			
E	Indicator only	digit 16 = N, Y	121 °C (250 °F) < T ≤ 260 °C (500 °F)
F	Indicator only	digit 16 = N	261 °C (501 °F) < T ≤ 537 °C (1000 °F)
U	Transmitter only	digit 16 = 1, 2, 3, A, B, C ① digit 16 = 8, 9	79 °C (175 °F) < T ≤ 260 °C (500 °F) 93 °C (200 °F) < T ≤ 260 °C (500 °F)
R	Indicator & transmitter	digit 16 = 1, 2, 3, A, B, C ① digit 16 = 8, 9	121 °C (250 °F) < T ≤ 260 °C (500 °F) 121 °C (250 °F) < T ≤ 260 °C (500 °F)
K	Transmitter only	digit 16 = 1, 2, 3, A, B, C ② & digit 18 = N	261 °C (501 °F) < T ≤ 454 °C (850 °F)
V	Indicator & transmitter	digit 16 = 1, 2, 3, A, B, C ②	261 °C (501 °F) < T ≤ 454 °C (850 °F)

① Matches external mount Jupiter with digit 3 = E, F, H
② Matches external mount Jupiter with digit 3 = K, L, M

18 | MEASUREMENT TYPE & INDICATION STYLE

Total level		
1	Orange / black metal flags	
2	Yellow / black metal flags	
3	Red / white metal flags (standard)	
4	Red / silver metal flags	+371 °C (+700 °F) and above
N	No indicator (For external use of external Jupiter mount only)	

19 | INDICATOR HOUSING MATERIAL & MEASURING SCALE ①

reveal Wide View Stainless Steel indicator	
A	Foot / Inch Measurement
M	Meter / Centimeter Measurement
C	Running Inch Measurement
D	Percent (0 – 100%) Measurement
P	No scale

Anodized Aluminum Housing	
1	Foot / Inch Measurement
8	Meter / Centimeter Measurement
N	No scale

① Aluminum indicator with glass window is required if the process operating temperature exceeds +800° F (+427° C).

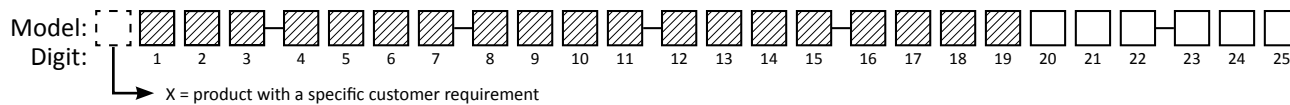

20 | STILLING WELL SIZE ^①

1	2" S10 ^②
2	2" S40 ^③
3	2½" S10 ^④
4	2½" S40 ^⑤
A	3" S10 ^⑥
B	3" S40 ^⑦
N	None

- ① Stilling well is recommended for indicator length of 122 cm (48") or greater
- ② Not available when digit 5 = B or digit 9 = 1, 2
- ③ Not available when digit 9 = 1, 2
- ④ Not available when digit 5 = B or digit 9 = 1, 2, C, D
- ⑤ Not available when digit 9 = 1, 2, C, D
- ⑥ Not available when digit 5 = B or digit 9 = 1, 2, A, B, C, D, H
- ⑦ Not available when digit 9 = 1, 2, A, B, C, D, H

21 | FLOAT DIAMETER (Consult Factory)

9	Custom
D	2"
8	2¼"
K	2½"
L	3"

22 | FLOAT LENGTH (Consult Factory)

9	Custom
A	6"
B	8"
C	10"
D	12"
E	14"

23-25 | VISUAL INDICATION LENGTH

X X X	Specify in INCHES (maximum = 212) when model code 2 is E
	Specify in CENTIMETERS (maximum = 538) when model code 2 is M
<p>Example #1: Center-to-Center is 84 inches. Enter as 084. (model digit 2 must be "E")</p> <p>Example #2: Center-to-Center is 124 centimeters. Enter as 124. (model digit 2 must be "M")</p> <p>Example #3: Center-to-Center is 124.25 inches. Enter as 124 inches and X the model for 124.25 inches. Consult factory for assistance.</p> <p>Example #4: Center-to-Center is 724 millimeters. Enter as 072 centimeters and X the model for 724 millimeters. Consult factory for assistance.</p>	

MODEL NUMBER - PLASTIC ATLAS

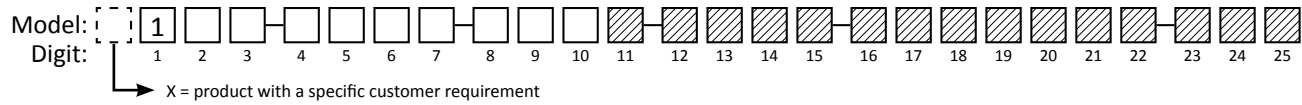

1 | PRODUCT NAME

6	Plastic Atlas™ Magnetic Level Indicator
---	---

2 | UNIT OF MEASUREMENT

E	English (inches)
M	Metric (cm)

3 | MOUNTING CONFIGURATION & CHAMBER CONSTRUCTION

Connection orientation	Chamber top	Chamber bottom
1 Side / Side	End Cap	Flange
2 Side / Side	Flange	End Cap
3 Side / Side	Flange	Flange

4 | CHAMBER/FLANGE RATING

A	150#
---	------

6 | CONSTRUCTION GRADE

1	Industrial Grade (standard)
---	-----------------------------

5 | MATERIAL OF CONSTRUCTION

1	PVC
2	CPVC
3	KYNAR
4	POLYPROPYLENE
5	FIBERGLASS

7 | CHAMBER FLANGE(S) TYPE

P	Full Face Socket Flange ^①
Q	Serrated Face Socket Flange ^②

^① Available when 5th digit = 1, 2, 3, 4

^② Available when 5th digit = 5

8 | PROCESS CONNECTION TYPE

1	Van Stone Socket Flange ^①
2	Full Face Socket Flange ^②
3	Serrated Face Socket Flange ^③

^① Available when 5th digit = 1, 2

^② Available when 5th digit = 1, 2, 3, 4

^③ Available when 5th digit = 5

9 | PROCESS CONNECTION SIZE

A	½" Flange
B	¾" Flange
C	1" Flange
D	1½" Flange
E	2" Flange

10 | GASKET STYLE FOR CHAMBER FLANGE(S)

N	None (if mating flanges are not supplied)
P	EPDM Rubber (+93 °C / +200 °F maximum) ^①
Q	Neoprene Rubber (+121 °C / +250 °F maximum) ^①
R	Buna-N Nitrile Rubber (+121 °C / +250 °F maximum) ^①
S	ePTFE soft ring (+232 °C / +450 °F maximum) ^①
T	VITON® (+149 °C / +300 °F maximum) ^①

^① Temperature limitations are primarily based on plastic construction.

Design Temperature °F (°C)	Digit 5			
	1	2	3	4
	PVC	CPVC	KYNAR	PP
73 (23)	150 [10.34]	150 [10.34]	140 [9.65]	20 [1.38]
80 (27)	150 [10.34]	150 [10.34]	133 [9.17]	19 [1.31]
90 (32)	150 [10.34]	150 [10.34]	122 [8.41]	18 [1.24]
100 (38)	124 [8.55]	124 [8.55]	112 [7.72]	17 [1.17]
110 (43)	100 [6.89]	100 [6.89]	105 [7.24]	16 [1.10]
115 (46)	90 [6.21]	90 [6.21]	99 [6.83]	15 [1.03]
120 (49)	80 [5.52]	80 [5.52]	95 [6.55]	15 [1.03]
125 (52)	70 [4.83]	70 [4.83]	92 [6.34]	14 [.97]
130 (54)	60 [4.14]	60 [4.14]	87 [6.00]	14 [.97]
140 (60)	44 [3.03]	44 [3.03]	81 [5.58]	13 [.90]
150 (66)	N.R.	N.R.	73 [5.03]	11 [.76]
160 (71)	N.R.	N.R.	69 [4.78]	10 [.69]
170 (77)	N.R.	N.R.	63 [4.34]	5 [.34]
180 (82)	N.R.	N.R.	59 [4.07]	N.R.
200 (93)	N.R.	N.R.	50 [3.45]	N.R.
210 (99)	N.R.	N.R.	46 [3.17]	N.R.
240 (116)	N.R.	N.R.	35 [2.41]	N.R.
280 (138)	N.R.	N.R.	25 [1.72]	N.R.

N.R. = Not Recommended

- Interpolation is permitted

- Fiberglass ratings not listed since they are application specific

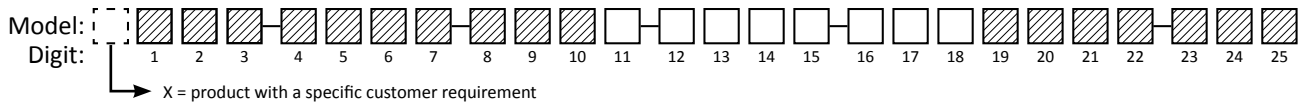

11 | CHAMBER BOLTING MATERIAL

N	None	
A	304 Stainless steel class 2	A193 Gr. B8 Class 2 / A194 Gr. 8
S	Zinc-plated Alloy Steel (+210 °C (+390 °F))	A193 Gr B7 / A194 Gr 2H

12 | VENT SIZE

N	None
1	1/2" ①
2	3/4" ①

13 | VENT TYPE

N	None
1	Threaded NPT-F (female) with plug

14 | DRAIN SIZE

N	None
1	1/2" ①
2	3/4" ①

15 | DRAIN TYPE

N	None
1	Threaded NPT-F (female) with plug

① Not Available when 5th digit = 3, 4

16 | CHAMBER MODIFICATION FOR MOUNTING OF OPTIONAL SWITCHES AND/OR TRANSMITTER

Atlas can be combined with various externally mounted accessories, including switches and transmitters. In these cases minor changes to the chamber and float design may be required.

For digit 16, match up the MLI product with the appropriate transmitter, switch or combination of both.

For OES/ORS switch, refer to the switch selection data for temperature limitations and insulation options. Match up the switch model code digit 7 with the MLI model codes 16 and 17.

For OCT transmitter, refer to OCT information for temperature limitations and match up the OCT model code with the MLI model codes 16 and 17.

For Jupiter transmitter, refer to JM4 information for temperature limitations and possible mounting configurations. Match up the Jupiter model code with the MLI model codes 16 and 17.

All transmitters and switches must be ordered separately.

N	No switch or transmitter added
---	--------------------------------

Switch only (no transmitter)	
Y	OES or ORS switch(es) clamp mounted to chamber

OCT reed chain transmitter (no switches)	
8	Top mount
9	Bottom mount

Jupiter magnetostrictive transmitter only (no switches)	
1	Top mount without offset ①
2	Top mount offset, with or without high temperature design
3	Bottom mount offset, with or without high temperature design

Jupiter magnetostrictive transmitter with at least one OES or ORS switch	
Mounting of Jupiter	Mounting of switches - clamp mounted to chamber
Top mount without offset ①	A
Top mount offset, with or without high temperature bend	B
Bottom mount offset, with or without high temperature bend	C

① Available only in combination with digit 3 = 1 and digit 13 = N or 1

17 | INSULATION OPTIONS – See Plastic Temperature Limitations

N	None
---	------

18 | MEASUREMENT TYPE & INDICATION STYLE

1	Orange / Black flags
2	Yellow / Black flags
3	Red / White flags

OPTIONAL EXTERNAL MOUNT LEVEL TRANSMITTERS

The Jupiter transmitter is a magnetostrictive level transmitter while the OCT transmitter is a reed chain level transmitter. Both types are mounted to the MLI via clamps.

Jupiter Model JM4 magnetostrictive transmitter

SELECTION DATA

Model:

J	M	4	5						
---	---	---	---	--	--	--	--	--	--

 Digit:

1	2	3	4	5	6	7	8	9	10
---	---	---	---	---	---	---	---	---	----

 X = product with a specific customer requirement

5 | SIGNAL OUTPUT

1	4-20 mA with HART
2	FOUNDATION fieldbus™ Communications

6 | SAFETY OPTIONS

0	None required for FOUNDATION fieldbus™
1	SIL 2 Hardware ①

7 | ACCESSORIES/MOUNTING

0	No Digital Display and Keypad - Integral
1	No Digital Display and Keypad - Remote 36" (0.91m) ②
2	No Digital Display and Keypad - Remote 144" (3.6m) ②
A	Digital Display and Keypad - Integral
B	Digital Display and Keypad - Remote 36" (0.91m) ②
C	Digital Display and Keypad - Remote 144" (3.6m) ②

8 | AREA CLASSIFICATION

0	General Purpose, Weatherproof (IP 67)
1	Intrinsically Safe / FISCO (cFMus)
3	Explosion-Proof / FNICO (cFMus)
A	Intrinsically Safe (ATEX & IEC)
B	Flame-Proof (ATEX & IEC)
C	Ex n (ATEX & IEC)
D	Dust Ex (ATEX & IEC)
1	FISCO Field Device (cFMus)
3	Explosion-Proof & FNICO Field Device (cFMus)

9 | HOUSING

1	Aluminum, Dual-Compartment
2	316 SS, Dual-Compartment

10 | CONDUIT CONNECTION & SUNSHADE OPTION

0	1/2" NPT
1	M20
2	1/2" NPT with Sunshade
3	M20 with Sunshade

① 3rd Party FMEDA report available

② Remote-mount transmitter not available with XP / Flame Proof approvals

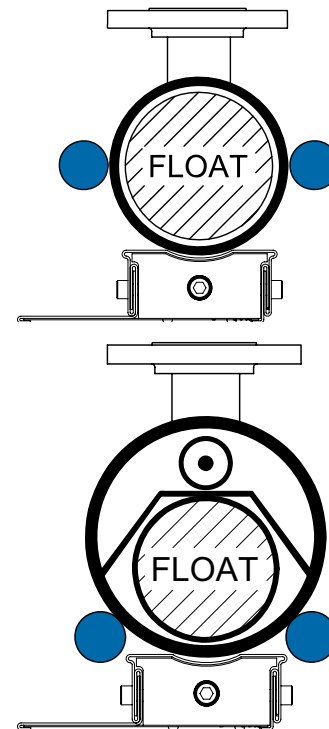

Probe mounting positions on Atlas™, Vector™, and Gemini™ Magnetic Level Indicators

Probe mounting positions on Aurora® MLI
 Probe proximity to the float is critical

Jupiter Model JM4 magnetostrictive external mount probe

X = product with a specific customer requirement

SELECTION DATA

Model:

2														
---	--	--	--	--	--	--	--	--	--	--	--	--	--	--

Digit:

--	--	--	--	--	--	--	--	--	--	--	--	--	--	--

→ X = product with a specific customer requirement

2 | MEASUREMENT SYSTEM

A	English	Probe length to be provided in inches
C	Metric	Probe length to be provided in centimeters

3 | CONFIGURATION

E	STANDARD Top Mount	suitable for process temperatures -40 to +260 °C (-40 to +500 °F)
F	STANDARD Top Mount Offset	
H	STANDARD Bottom Mount Offset	
K	HIGH-TEMP Top Mount	suitable for process temperatures +501 to +850 °F (+261 to +454 °C)
L	HIGH-TEMP Top Mount Offset	
M	HIGH-TEMP Bottom Mount Offset	
R	CRYOGENIC Top Mount	suitable for process temperatures -196 to +66 °C (-320 to +150 °F)
S	CRYOGENIC Top Mount Offset	
T	CRYOGENIC Bottom Mount Offset	

4-5 | MOUNTING SIDE

00	Left-Side MLI Mount
01	Right-side MLI Mount

6 | PROBE MATERIAL OF CONSTRUCTION

A	Powder-Coated Aluminum Sensor Enclosure with 316 SS Probe (Available only with Digit 3, Options F, H, L, M)
1	316 SS Sensor Enclosure with 316 SS Probe

7 | PROBE OPTIONS

N	None
V	Vibration-resistant probe mounting

8 | CHAMBER SIZE (FOR MOUNTING HARDWARE)

Select these options if chamber DOES NOT contain high-temp insulation

1	2" (or if digit 20 of MLI model code is 1, 2, or 7)
2	2½" (or if digit 20 of MLI model code is 3, 4, 5, or 6)
3	3" (or if digit 20 of MLI model code is A, B, C, or D)
4	4" (or if digit 20 of MLI model code is E, F, G, H, or J)
5	¾" (for Atlas Top Mount Configuration only)
0	None. No mounting clamps required.

Select these options if chamber DOES contain high-temp insulation

E	2" (or if digit 20 of MLI model code is 1, 2, or 7)
F	2½" (or if digit 20 of MLI model code is 3, 4, 5, or 6)
G	3" (or if digit 20 of MLI model code is A, B, C, or D)
H	4" (or if digit 20 of MLI model code is E, F, G, H, or J)
J	¾" (for Atlas Top Mount Configuration only)
0	None. No mounting clamps required.

9 | UNUSED

0	None
---	------

10 | LEVEL/INTERFACE MEASUREMENT PREFERENCE

1	Measure Only the Total Liquid Level
2	Measure Only the Interface Level
3	Measure Both Total and Interface Level

11-12 | UNUSED

00	None
----	------

13-15 | PROBE LENGTH

Specify required insertion length (see below)	
XXX	Example: 87 inches = 087 Code 2 must be "A"
	Example: 120 centimeters = 120 Code 2 must be "C"

Note: Maximum Probe Length = 400 inches (999 cm)

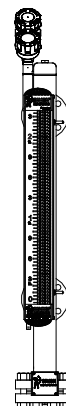

Top Mount Configuration

Probe Length = Center-to-Center + 8 in. (20 cm)

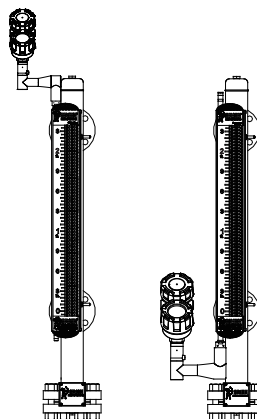

Top/Bottom Mount Offset Configuration

Probe Length = Center-to-Center + 6 in. (15 cm)

OPTIONAL EXTERNAL MOUNT LEVEL TRANSMITTERS

OCT reed chain transmitter

The OCT analog transmitter mounts directly to the side of the MLI and provides a continuous 4–20 mA output signal proportional to the liquid level. Using simple and reliable reed switches surface mounted to a printed circuit board, the unit provides a resolution of ± 13 mm (0.50"). Activated by the magnetic field of the float, the transmitter is totally non-invasive.

SELECTION DATA

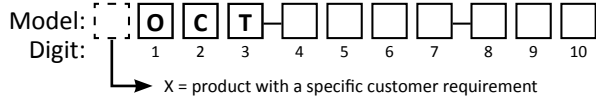

1-3 | BASIC MODEL NUMBER

OCT	Reed chain transmitter (FM/CSA explosion proof)
-----	---

4 | HOUSING / CABLE ENTRY

A	IP 66, cast aluminum, 1/2" NPT-F cable entry
S	IP 66, 316 stainless steel, 3/4" NPT-F cable entry

5 | MOUNTING POSITION

A	Top mount, right hand
B	Top mount, left hand
C	Bottom mount, right hand
D	Bottom mount, left hand

6 | CHAMBER MOUNTING CODE

No insulation present on MLI (MLI model code digit 17 = N)		
1	MLI model code digit 20 = 1, 2	MLI model code digit 3 ≠ T
2	MLI model code digit 20 = 3, 4, 5, 6	MLI model code digit 3 ≠ T
3	MLI model code digit 20 = A, B, C, D	MLI model code digit 3 ≠ T
4	MLI model code digit 20 = E, F, G, H, J	MLI model code digit 3 ≠ T
5	MLI is a top mount design	MLI model code digit 3 = T

MLI with high temperature insulation (MLI model code digit 17 = U, R)		
E	MLI model code digit 20 = 1, 2	MLI model code digit 3 ≠ T
F	MLI model code digit 20 = 3, 4, 5, 6	MLI model code digit 3 ≠ T
G	MLI model code digit 20 = A, B, C, D	MLI model code digit 3 ≠ T
H	MLI model code digit 20 = E, F, G, H, J	MLI model code digit 3 ≠ T
J	MLI is a top mount design	MLI model code digit 3 = T

7 | UNIT OF MEASUREMENT

M	Metric (cm)
E	English (inches)

8-10 | MEASURING LENGTH - specify per cm (0.39") increment

030	Min 30 cm (12")	
500	503 cm (198")	FM approval
500	503 cm (198")	CSA approval

Match measuring length with visual indication length of MLI.
Sensor length = measuring length + 20 cm (8").

DIMENSIONS mm (inches)

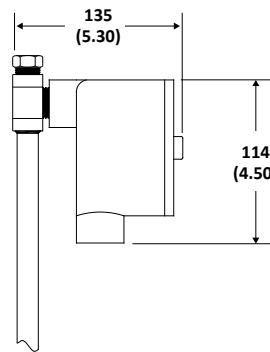
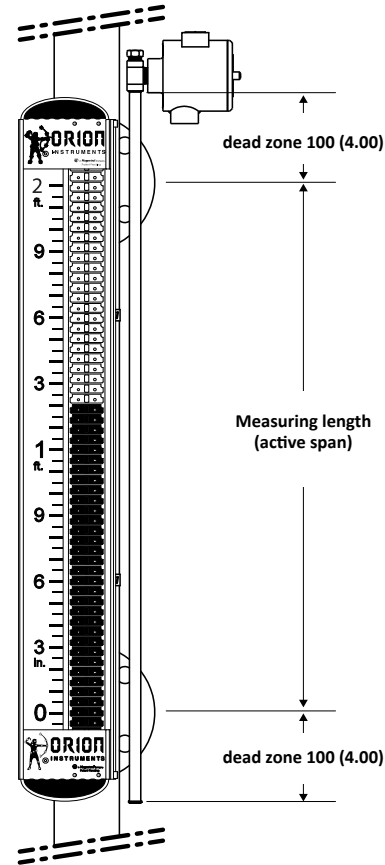

Aluminum housing

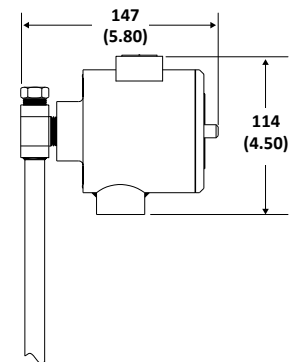

Stainless steel housing

OPTIONAL POINT LEVEL SWITCHES

The OES level switch is a cam-operated microswitch while the ORS level switch is a hermetically sealed reed switch. Both types can be mounted to the MLI either via clamps or attached to a switch mount rod and are field adjustable. Simply loosen the mounting clamps and position at the desired location. Ensure that the switch always remains in close proximity to the internal float.

A switch mount rod is an available alternative method for mounting the switch to an MLI when chamber insulation blanket is present. The rod assembly, which is welded to the MLI chamber, allows the switch to slide along the full length. When the desired position is selected, simply tighten it in place.

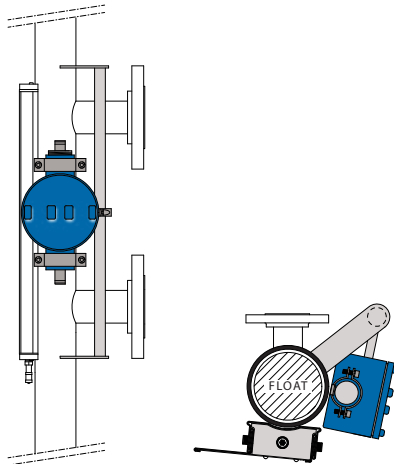

OES switch attached to switch mount rod

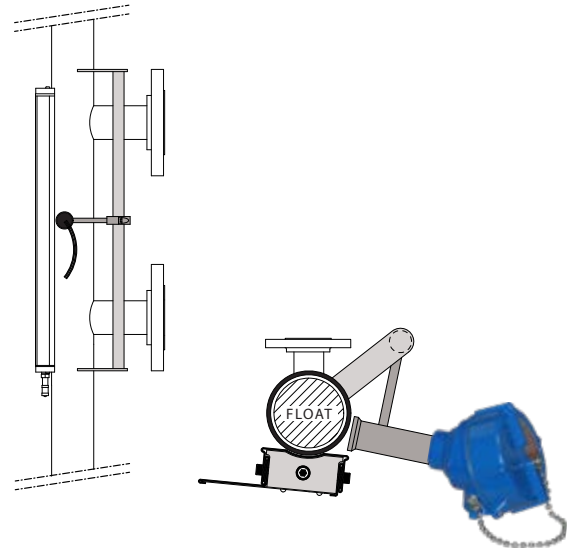

ORS switch attached to switch mount rod

OES bi-stable DPDT microswitch

The OES level switch is actuated by simple magnetic coupling. As the liquid level moves, the MLI float (with its internal magnets and flux rings) follows. When the float moves into the proximity of the microswitch, the switch magnet interacts with the float's magnetic field actuating the switch. The bi-stable design of the switch ensures that it will not reset until the float passes the switch in the opposite direction.

SELECTION DATA

Model:

Digit: 1 2 3 4 5 6 7 8 9 10

X = product with a specific customer requirement

1-3 | BASIC MODEL NUMBER

O E S	DPDT microswitch
-------	------------------

4 | HOUSING / CABLE ENTRY

A	IP66, cast aluminum, 3/4" NPT-F cable entry (2 entries - 1 plugged)
S	IP66, 316 stainless steel, 3/4" NPT-F cable entry (2 entries - 1 plugged)

5 | APPROVAL

N	Weatherproof
1	FM/CSA explosion proof

6 | CHAMBER MOUNTING CODE

N	No mounting clamps ①
1	MLI model code digit 20 = 1 or 2 (2" chamber)
2	MLI model code digit 20 = 3, 4, 5 or 6 (2 1/2" chamber)
3	MLI model code digit 20 = A, B, C or D (3" chamber)
4	MLI model code digit 20 = E, F, G, H or J (4" chamber)
5	MLI model code digit 3 = T (top mount design (3/4" chamber))

① When Digit 7 = R

7 | MOUNTING

C	Clamp mounted to chamber T ≤ 121 °C (250 °F)
P	Clamp mounted to chamber with insulation pad 121 °C (250 °F) < T ≤ 260 °C (500 °F)
R	Attached to switch mount rod ② T ≤ 260 °C (500 °F)

② When Digit 6 = N

DIMENSIONS mm (inches)

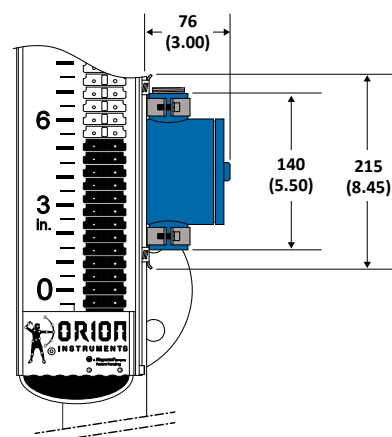

ORS hermetically sealed bi-stable SPDT reed switch

The ORS level switch is actuated by the magnetic field produced by the MLI float. As the liquid level moves, the MLI float (with its internal magnets and flux rings) follows. When the float moves into the proximity of the reed switch, the switch is actuated. The bi-stable design of the switch ensures that it will not reset until the float passes the switch in the opposite direction.

SELECTION DATA

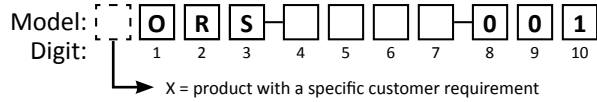

1-3 | BASIC MODEL NUMBER

ORS	Hermetically sealed SPDT reed switch
-----	--------------------------------------

4 | HOUSING / CABLE ENTRY

1	Stainless body without junction box
A	Stainless body with cast aluminum junction box, IP 66, 3/4" NPT-F cable entry
S	Stainless body with stainless steel junction box, IP 66, 3/4" NPT-F cable entry

5 | APPROVAL

1	FM/CSA
2	FM/CSA: 24 volt maximum
A	ATEX (Digit 4 = A or S)
N	General Purpose

6 | CHAMBER MOUNTING CODE

1	MLI model code digit 20 is 1 or 2 (2" chamber)	MLI model code digit 3 ≠ T
2	MLI model code digit 20 is 3, 4, 5 or 6 (2½" chamber)	MLI model code digit 3 ≠ T
3	MLI model code digit 20 is A, B, C, or D (3" chamber)	MLI model code digit 3 ≠ T
4	MLI model code digit 20 is E, F, G, H, or J (4" chamber)	MLI model code digit 3 ≠ T
5	MLI is a top mount design (¾" chamber)	MLI model code digit 3 = T
N	No mounting clamps ①	

7 | MOUNTING

C	Clamp mounted on MLI (standard)	T ≤ 121 °C (250 °F)
P	Clamp mounted on MLI with insulation pad	121 °C (250 °F) < T ≤ 260 °C (500 °F)
R	Attached to switch mount rod Digit 6 = N	T ≤ 260 °C (500 °F)

DIMENSIONS

mm (inches)

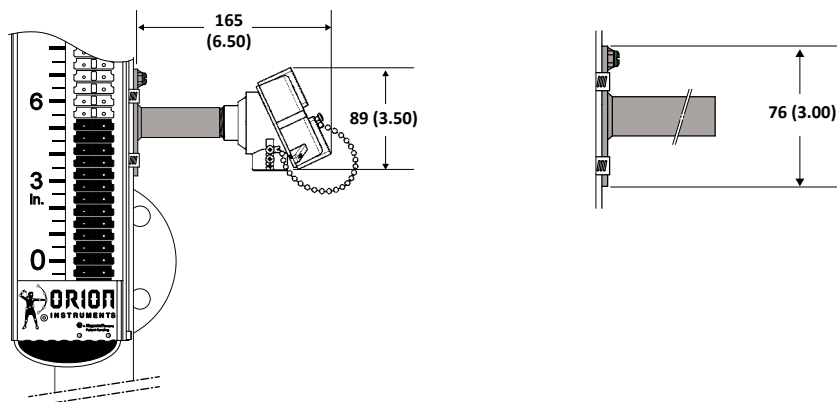



BULLETIN: ORI-142.5
EFFECTIVE: August 2022
SUPERSEDES: March 2021