



Rotating cleaning nozzle »PVDF MicroWhirly« Series 500.191

Series 500.191

The PVDF MicroWhirly is made entirely from PVDF and designed to work in a corrosive environment. It is also suitable for contact with food and the application of foam, and can be used for cleaning equipment – all for a very good price-performance ratio.



Max. tank diameter[m]

0 | 1 | 2 | 3 | 4 | 5 | 6 | 7 | 8 | 9



Material
PVDF



Max. temperature
90 °C



Recommended operating pressure
2 bar



Installation
Operation in every direction is possible



Filtration
Line strainer with a mesh size of 0.3 mm/50 mesh





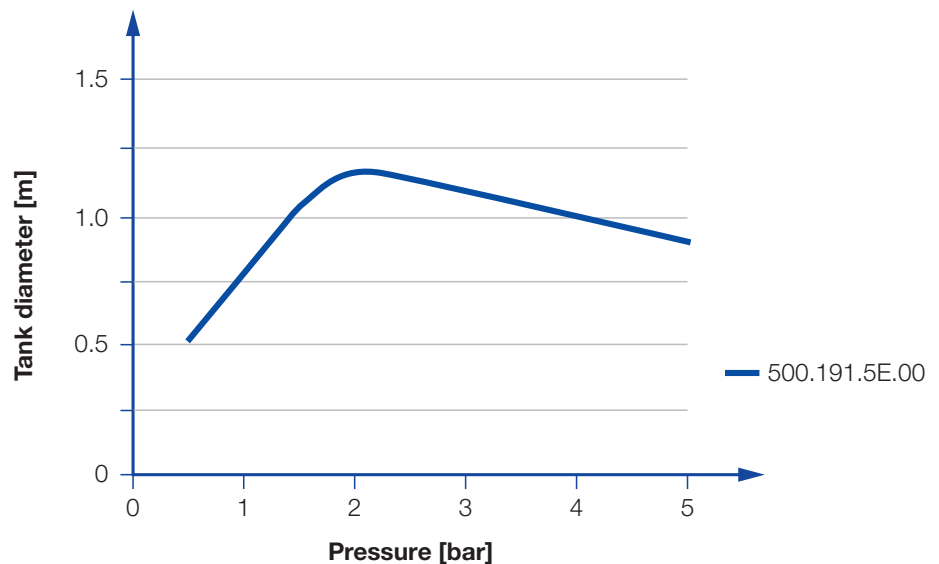

Bearing
Slide bearing made of PVDF

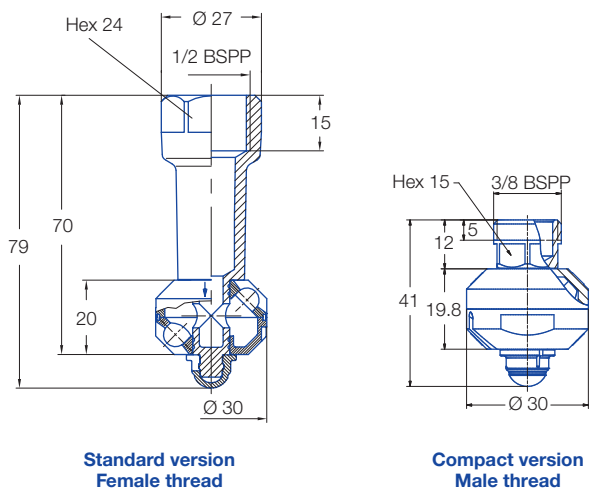

Overview of the tank diameter, depending upon the pressure of series 500.191





Standard version

Spray angle 	Ordering number Type	E Ø [mm]	Connection BSPP female	V̇ [l/min]				Max. tank diameter [m]
				p [bar] (p _{max} = 5 bar)				
				1	2	3	at 40 psi [US gal/min]	
180° 	500.191.5E.02	2.2	1/2"	9	13	16	4	0.8
180° 	500.191.5E.01	2.2	1/2"	9	13	16	4	0.8
270° 	500.191.5E.31	2.2	1/2"	14	20	25	6	1.1
360° 	500.191.5E.00	2.2	1/2"	14	20	25	6	1.1

E = narrowest free cross-section

The maximum tank diameter shown above applies for the recommended operating pressure and is indicative only. The cleaning result is also affected by the type of soiling.

Compact version

Spray angle 	Ordering number Type	E Ø [mm]	Connection BSPP male	V̇ [l/min]				Max. tank diameter [m]
				p [bar] (p _{max} = 5 bar)				
				1	2	3	at 40 psi [US gal/min]	
180° 	500.191.5E.21	2.2	3/8"	9	13	16	4	0.8
360° 	500.191.5E.22	2.2	3/8"	14	20	25	6	1.1

E = narrowest free cross-section

The maximum tank diameter shown above applies for the recommended operating pressure and is indicative only. The cleaning result is also affected by the type of soiling.

Information on operation

- The PVDF MicroWhirly is not suitable for operation with compressed air or any other gas. Operation above the recommended operating pressure has negative effects on the cleaning result and wear.